



Manual Installation Instructions

Note: The Fire Ring should not sit deeper than 1/2" below the Top Lip of the bowl.

1. Using 1/4" Pea Gravel, fill the lower area of the bowl to 1/2" below the Top Lip of the bowl.
2. Place the Fire Ring on top of Pea Gravel, making sure it is centered.
3. Top the bowl with Fire Glass or Lava Rock.

Manual Light

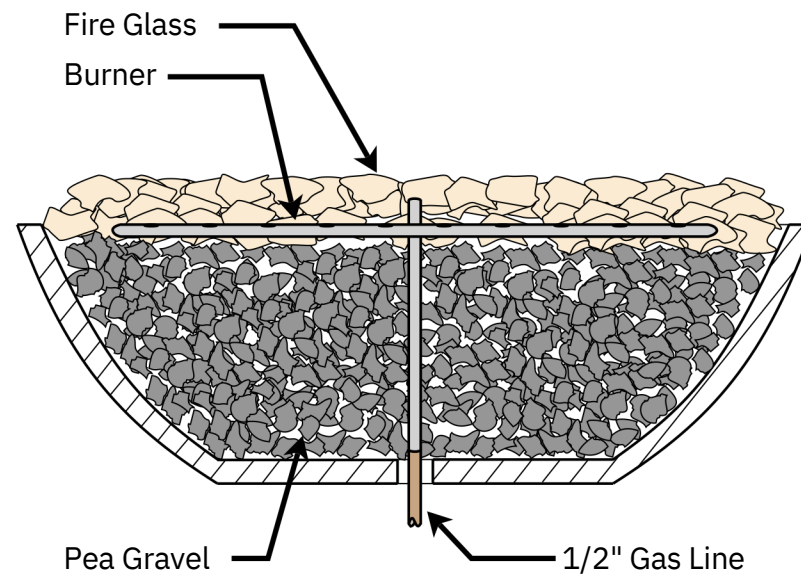

Remote Module AEWIS

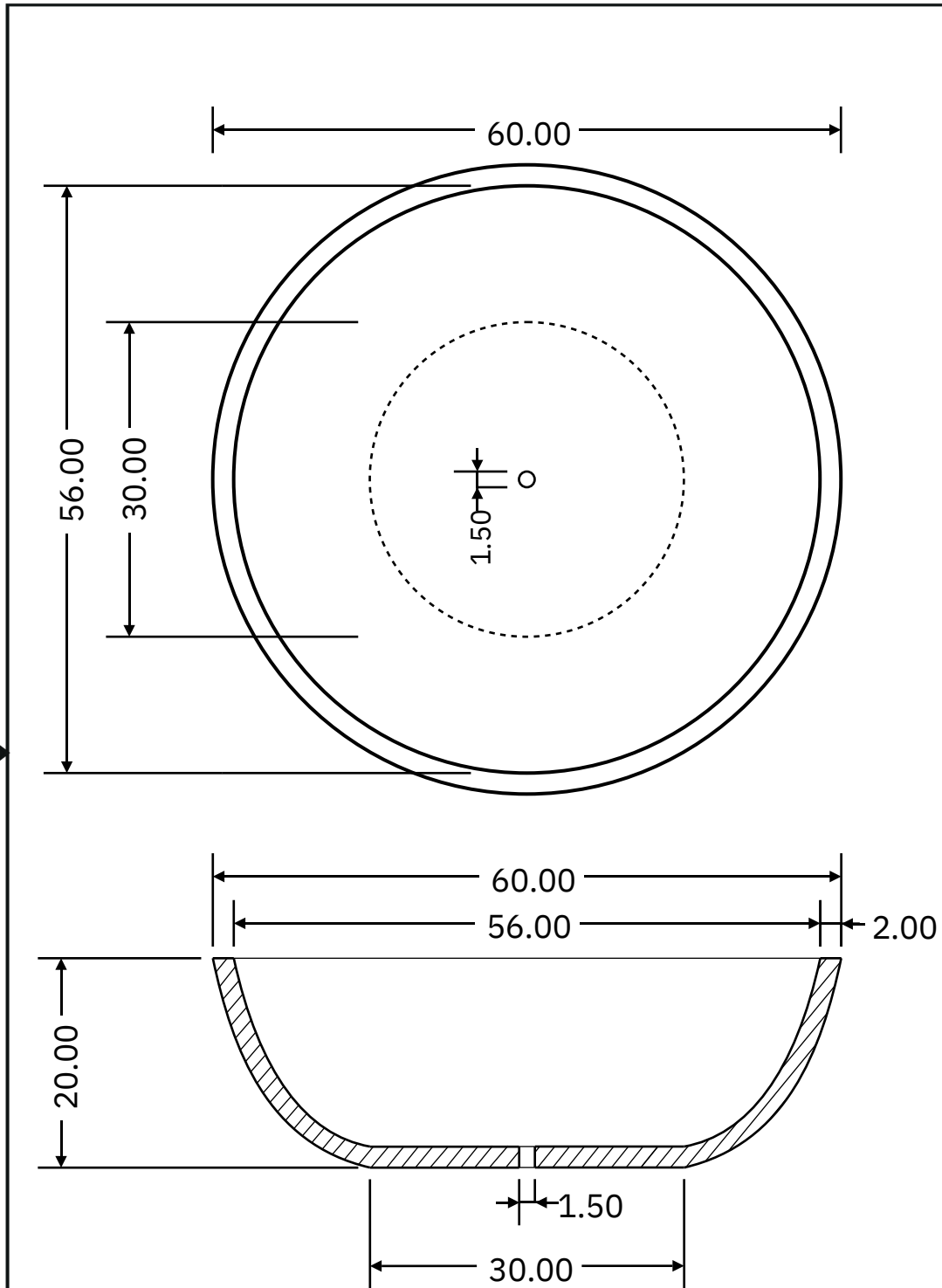
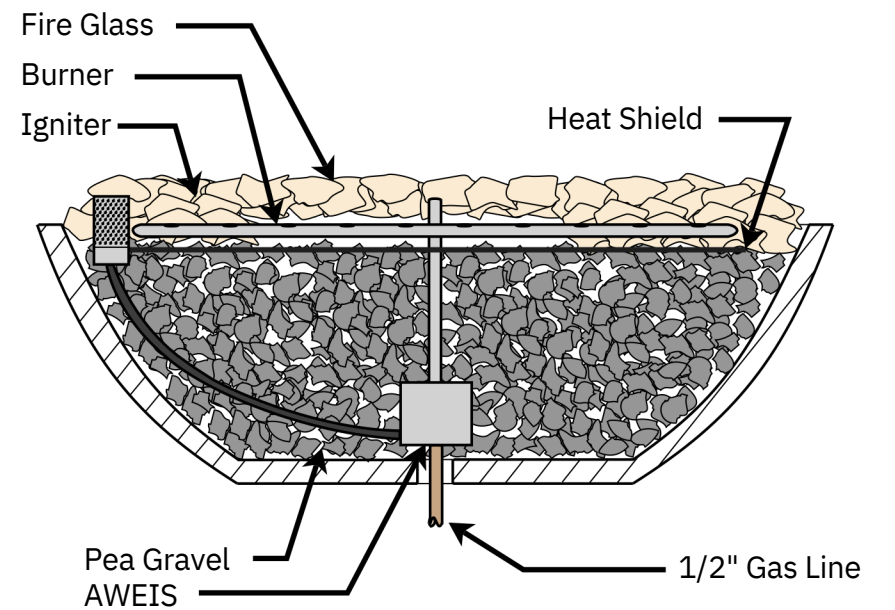

Concrete bowls are formed with fiber reinforced concrete with a water sealer additive and color all through the bowl. Cured for strength and durability.

Concrete Fire Bowl Round 60"			
	Dimensions are in Inches		
12 / 15 / 2013	Size	File No.	Rev
	Scale 1:16	Drawn: Edward Morgan	Sheet 1

WS2107

